







MM 25





2,5 t

CE







-  Sollevatore mobile monocolonna
-  Mobile single post lift
-  Mobile Einsäulen-Hebebühne
-  Pont élévateur mobile mono colonne
-  Elevador móvil monocolumna

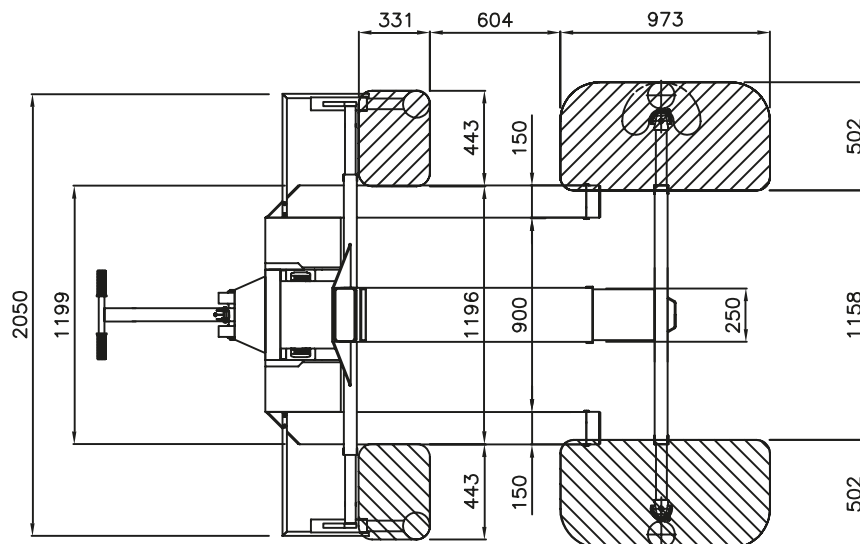
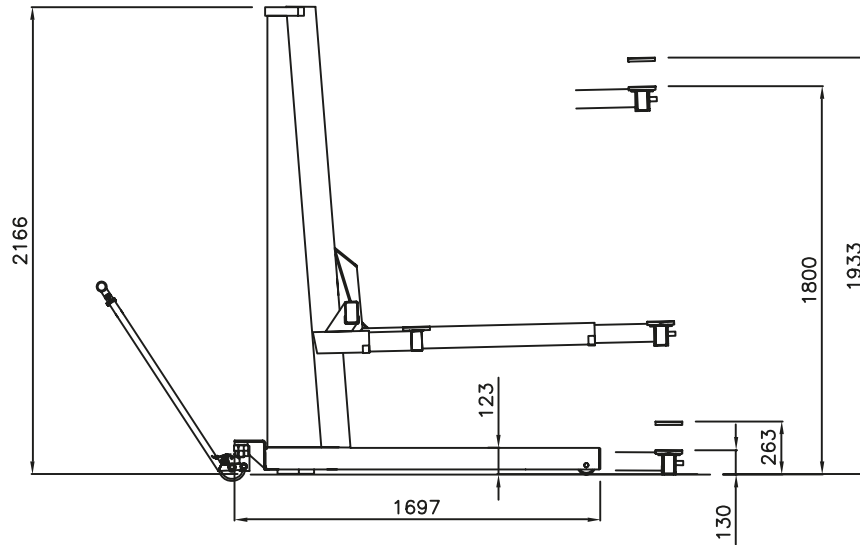

-  Sicurezze meccaniche, elettriche • ed idrauliche • Sollevatore multi-uso con piattaforma di carico estremamente versatile • Mobile, quindi utilizzabile sia in interno che esterno • Adatto per meccanici, carrozzieri, gommisti stazioni di servizio ed elettrauto • Adatto per interventi veloci • Adatto per interventi sia sulla carrozzeria che sulla parte meccanica • Adatto per posizionare l'autovettura sui banchi di riscontro • Dimensioni compatte • Funzionamento: elettroidraulico
-  Equipped with mechanical, electrical and hydraulic safety devices • Multi-purpose vehicle lift with very versatile load platform • Mobile, thus suitable for indoor and outdoor • Suitable for mechanics, body shops, tyre dealers, petrol stations, vehicle electricians • Rapidly available for any lifting job • Can lift the vehicles to easily operate both on the body and on the mechanical part • Suitable to fit cars on car benches • Compact • Operation: electro-hydraulic
-  Mit mechanischen, elektrischen und hydraulischen Sicherheitsvorrichtungen • Mehrzweck-Fahrzeugheber mit vielseitig einsetzbarer Hubplattform • Fahrbar; kann sowohl im Innern als auch im Aussenbereich eingesetzt werden • Geeignet für Garagen, Karosseriespengler, Tankstellen, Autoelektriker usw. • Geeignet für Schnelleinsätze • Geeignet für Arbeiten an der Karosserie und an der Fahrzeugmechanik • Geeignet zum Auflegen von PKW's auf Richtbänke • Kompakt • Funktionsweise: elektrohydraulisch
-  Équipé avec sécurités mécaniques, électriques et hydrauliques • Elévateur multi-usage avec plateforme de levage extrêmement versatile • Mobile, donc utilisable aussi bien à l'intérieur qu'à l'extérieur • Indiqué pour mécaniciens, carrossiers, stations-service, électriciens auto etc. • Indiqué pour levages rapides • Indiqué pour travaux aussi bien sur la carrosserie que sur les parties mécaniques des voitures • Utile pour placer les voitures sur les bancs de redressage • Compact • Fonctionnement: électrohydraulique
-  Seguridades mecánicas, eléctricas e hidráulicas • Elevador multiuso con plataforma de carga extremadamente versátil • Móvil, por lo tanto utilizable tanto en interiores como en exteriores • Apto para mecánicos, planchistas, especialistas en neumáticos, estaciones de servicio y talleres de electricidad del automóvil • Apto para actuaciones rápidas • Apto para actuaciones tanto en la carrocería como en la parte mecánica • Apto para colocar el vehículo en los bancos de enderezamiento • Dimensiones compactas • Funcionamiento: electro-hidráulico



 Dati tecnici	 Technical data	 Technische Eigenschaften	 Caractéristiques techniques	 Datos técnicos	
Portata	Capacity	Tragfähigkeit	Capacité	Capacidad	2.500 kg
Peso	Weight	Gewicht	Poids	Peso	700 kg
Salita/Discesa	Lifting/lowering	Hub/Senkzeit	Levage/descente	Subida/Bajada	25/25 s
Altezza di sollevamento	Lifting height	Hubhöhe	Hauteur de levage	Altura de elevación	1933 mm
Altezza minima	Min. height	Mindesthöhe	Hauteur min.	Altura minima	130 mm
Motore	Motor	Motorleistung	Puissance moteur	Motor	2,2 kW - 3 ph 230 400V/50 Hz

 Opzioni	 Optionals	 Sonderzubehör	 Options	 Opcionales
--	--	--	--	---

Esecuzione con motore monofase • **Single-phase motor** • Moteur monophasé • Ausführung mit Einphasenmotor • Motor monofásico

The company reserves the right to introduce improvements in design or specification without prior notice